

**Cod. 015730 CASTELLO DOLOMITI**  
**Cod. 015731 CASTELLO DOLOMITI INOX**  
**LEGNOLANDIA** | Rev. 0



art. 015730



art. 015731

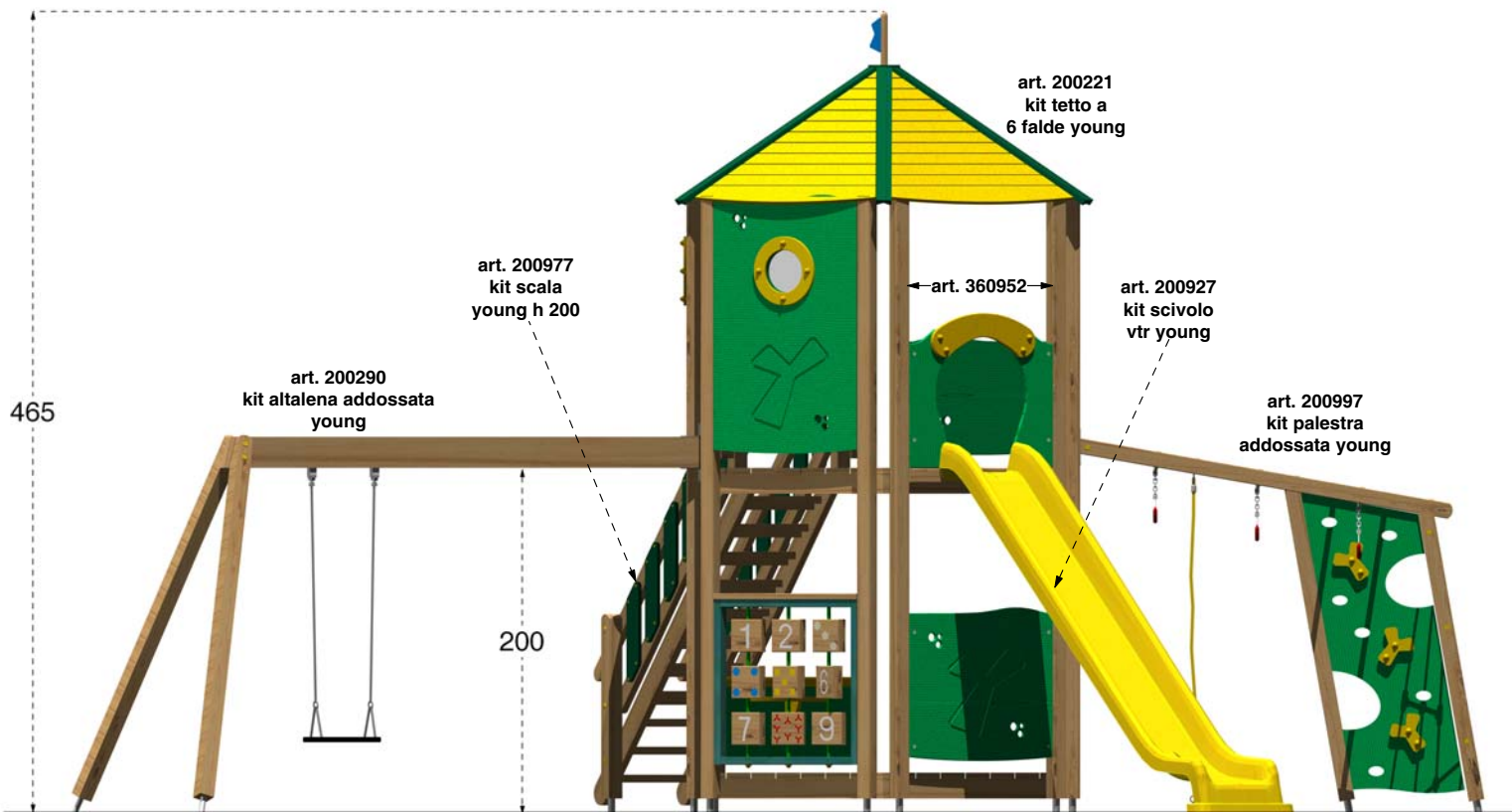

DATI DI SICUREZZA / SAFETY DATA		EN 1176 - EN 1177
art. 015730 - 015731		
ALTEZZA DI CADUTA LIBERA max (HIC) / FALL HEIGHT (HIC)	200 - 209 cm	
SPAZIO DI CADUTA / FALL SPACE	67,0 mq	
PAVIMENTAZIONE IN PIASTRE ELASTICHE / ELASTIC TILES PAVEMENT	78,0 mq	
ETA' USO CONSIGLIATA / RECOMMENDED AGE	da 3 a 14 anni	
Per la manutenzione consultare l'apposita scheda fornita col gioco		
For maintenance see instructions supplied with the game		

PAVIMENTAZIONI DI SICUREZZA  
 SAFETY PAVEMENT

Su tutte le attrezzature per aree da gioco con un'altezza di caduta libera superiore a 60 cm bisogna prevedere il rivestimento dello spazio di caduta con una superficie ammortizzante.

On all playground equipment with a free fall height superior to 60 cm a surface cushioning has to be provided which covers the fall area.



PRATO e TERRICCIO /  
 LAWN and GROUND  
 Altezza di caduta /  
 Fall height < o = 100 cm



SABBIA pezzatura /  
 SAND size 0,2-2 mm  
 GHIAIA pezzatura /  
 GRAVEL size 2-8 mm  
 Spessore minimo /  
 Thickness 30 cm  
 Altezza di caduta fino a /  
 Fall Height up to 300 cm



CORTECCIA pezzatura /  
 BARK size 20-80 mm  
 TRUCIOLI pezzatura /  
 CHIPS size 5-30 mm  
 Spessore minimo /  
 Thickness 30 cm  
 Altezza di caduta fino a /  
 Fall Height up to 300 cm

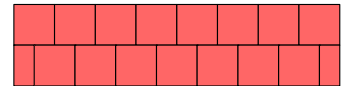

PIASTRE ELASTICHE /  
 ELASTIC TILES

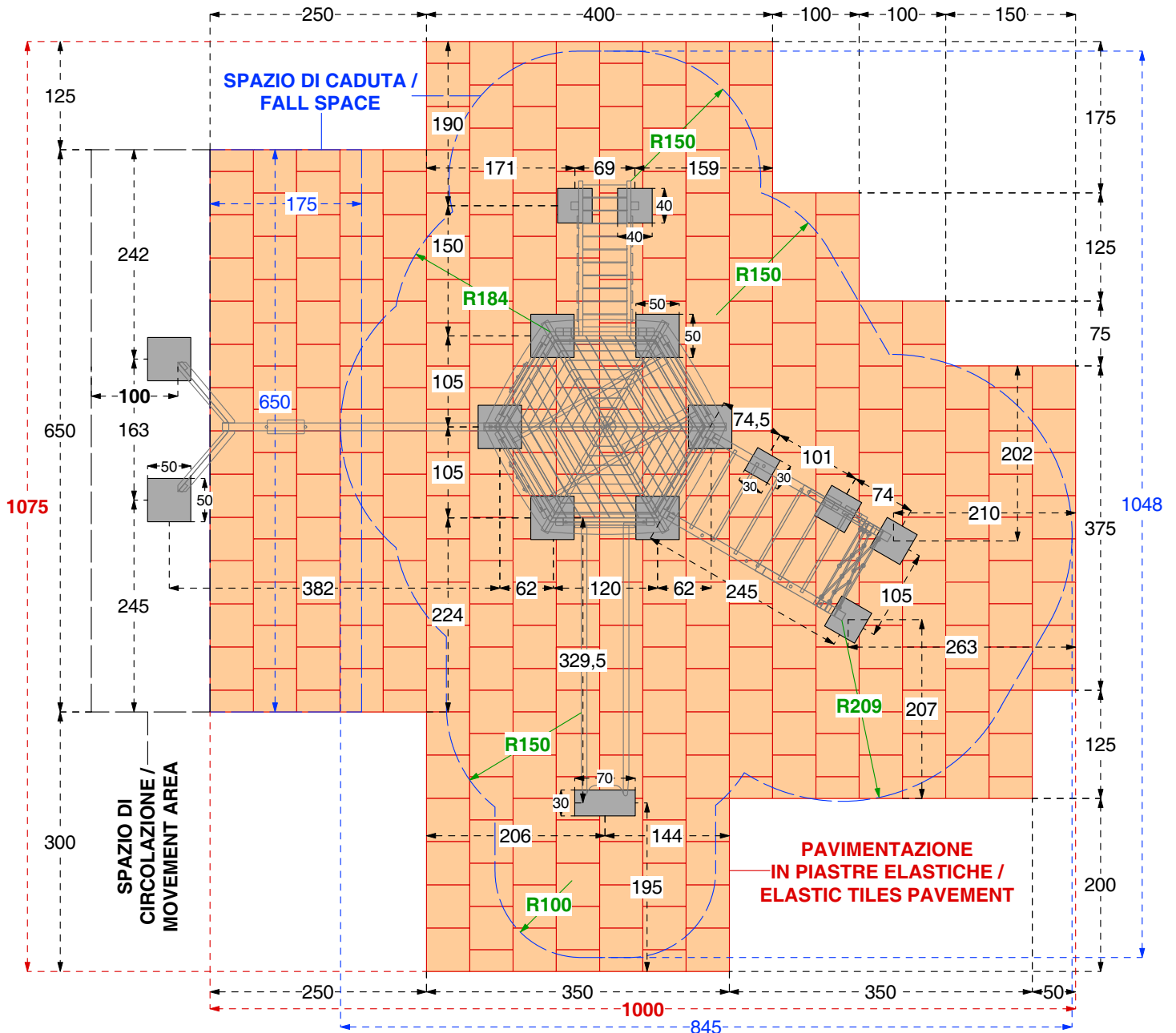

**Cod. 015730 CASTELLO DOLOMITI**  
**Cod. 015731 CASTELLO DOLOMITI INOX**  
**LEGNOLANDIA** | Rev. 0



**DISPOSIZIONE PARAPETTI**

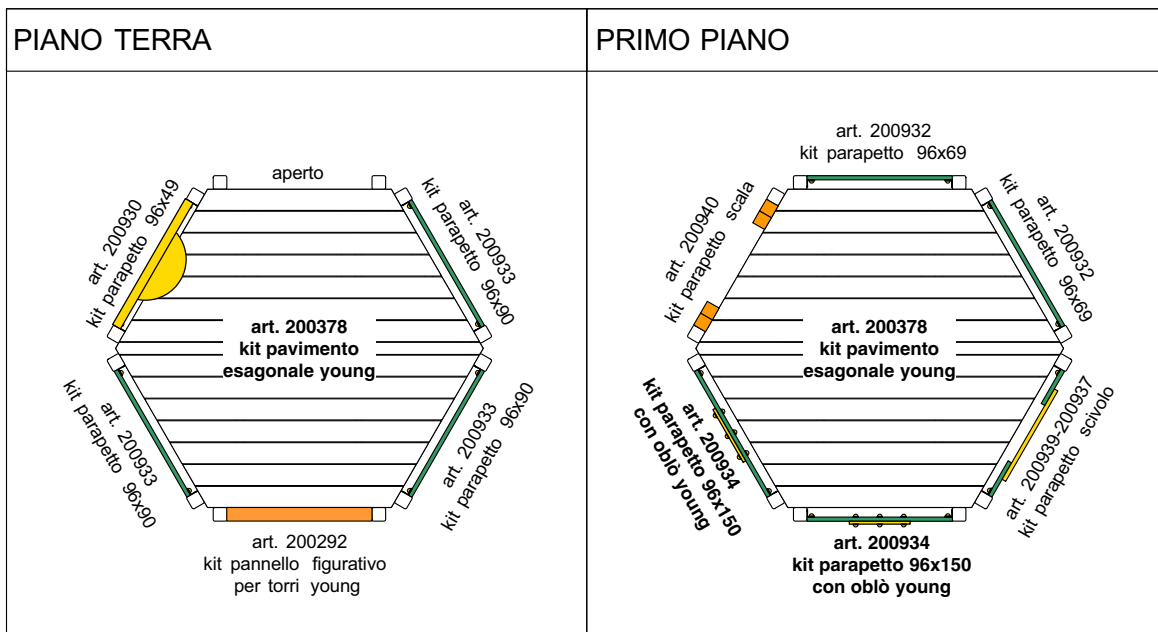

**FISSAGGIO A TERRA TORRE**

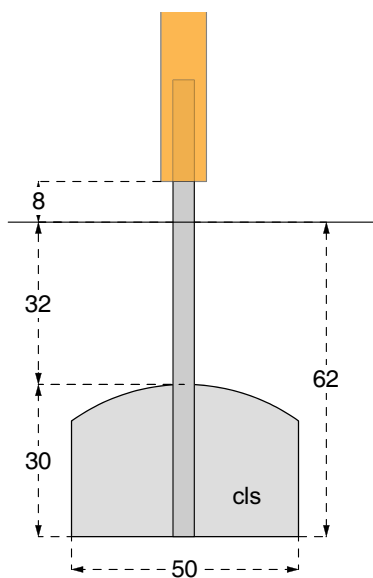

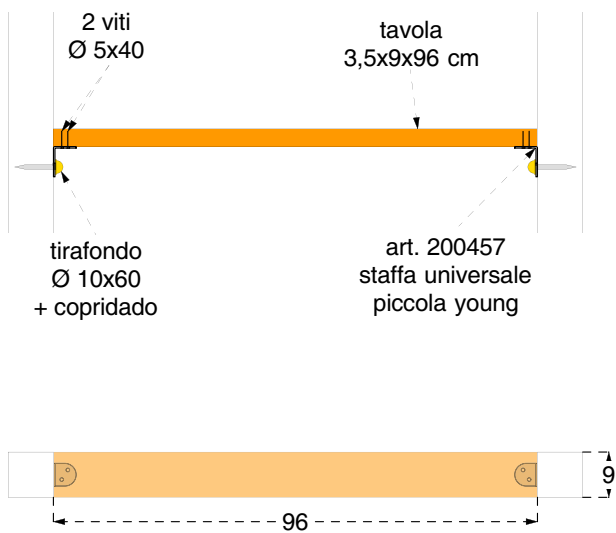
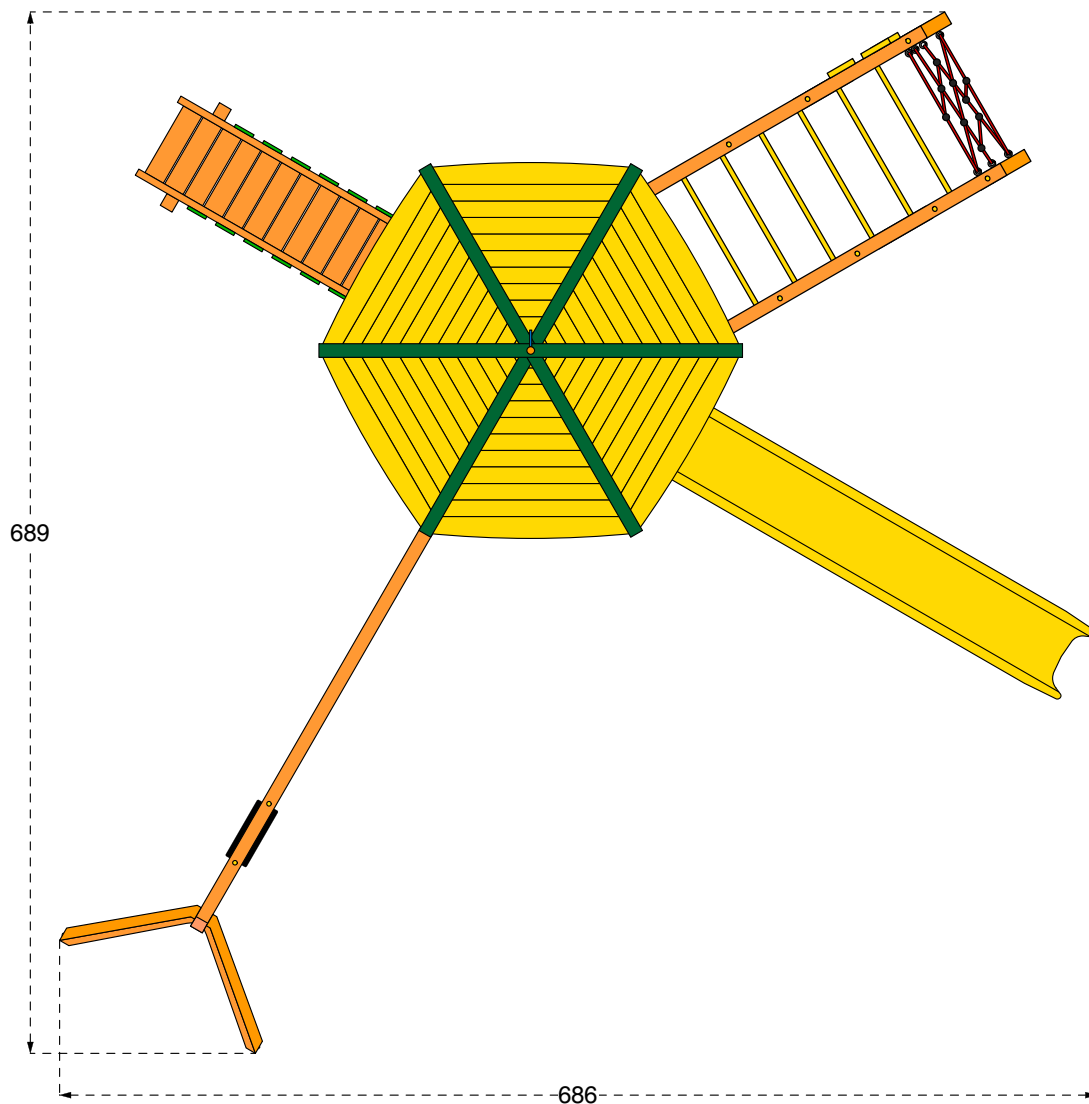

### POSIZIONAMENTO TAVOLA

